



Ginger

Joan Gaspar

marset



Ginger 60C

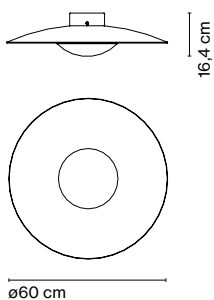

Ginger 42C

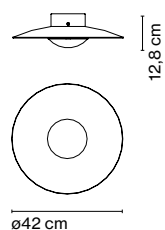

Ginger 32C

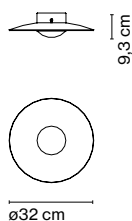

Ginger 20C

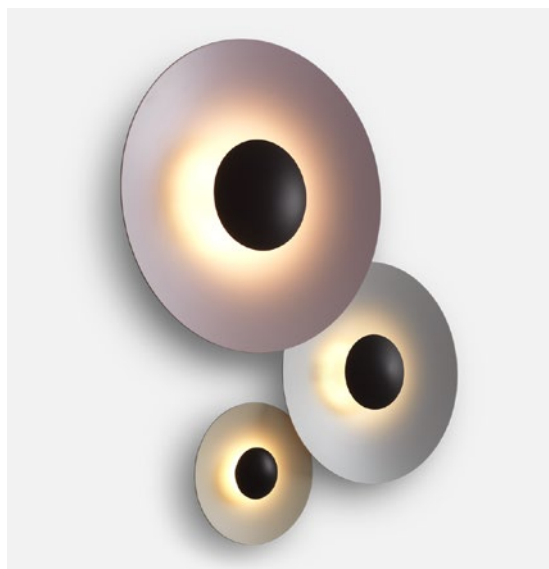
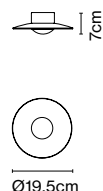
**Ginger 20C**

LED SMD 6W 350mA 2700K CRI90
Light Source 139lm
(included)

Ginger 32C

LED SMD 11,5W 700mA 2700K CRI90
Light Source 1066lm Luminaire 350lm
(included)

Ginger 42C









LED SMD 21,7W 700mA 2700K CRI90
Light Source 2130lm Luminaire 698lm
(included)

Ginger 60C

LED SMD 28W 700mA 2700K CRI90
Light Source 3023lm Luminaire 1165lm
(included)

- [Download](#) Assembly Instructions
- [Download](#) Energy label
- [Download](#) 2D
- [Download](#) 3D
- [Download](#) Photometric Data

**Pressed wood or brushed aluminum diffuser.
Injected and lacquered black metal matte alu-
minium dissipater.**

-  Oak - Oak
-  Wenge - Wenge
-  Oak - White
-  Wenge - White
-  Brushed brass - Brushed brass
-  Black - White
-  Mauve (RAL 010 70 10)
-  Sand (RAL 050 85 10)
-  Stone Grey (RAL 000 65 00)

dimming*

*Phase cut dimmer lea-
ding and trailing edge
(Triac)

Wood is a great ally of cozy lighting. It is a material that is hard to mold, a challenge that the Ginger collection neatly resolves. The combination of sheets of wood and paper pressed together under high pressure achieves a laminate that appears almost entirely flat. Within the same collection, Ginger is also published in metal.

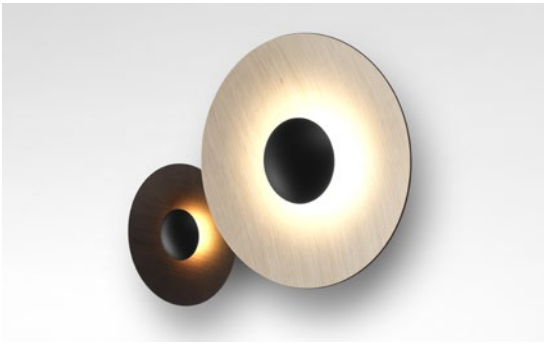

Accessory C2 20/32

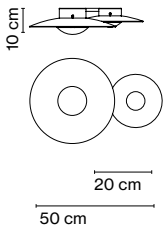

Accessory C3 20/32/42

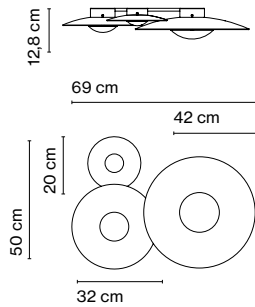

Accessory C2 32/42

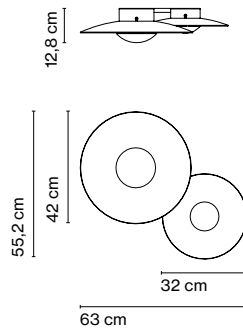

Accessory C3 32/42/60

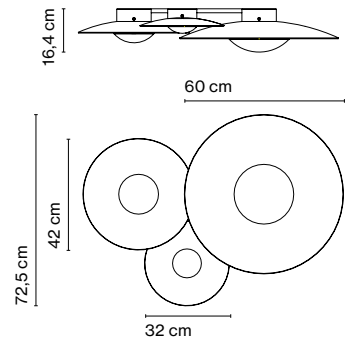

Accessory C2 42/60

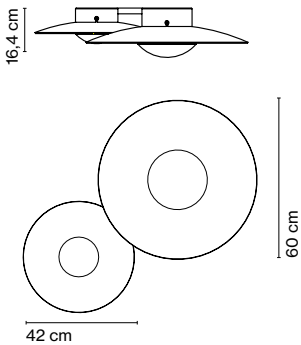

Accessory C2 20/32

LED SMD 13,9W 700mA 2700K CRI90
Light Source 1205lm
(included)

Accessory C3 20/42/60

LED SMD 35,6 700mA 2700K CRI90
Light Source 3335lm
(included)

Accessory C2 32/42

LED SMD 33,2W 700mA 2700K CRI90
Light Source 3196lm Luminaire 1048lm
(included)

Accessory C3 32/42/60

LED SMD 60,2W 700mA 2700K CRI90
Light Source 6219lm Luminaire 2213lm
(included)

Accessory C2 42/60

LED SMD 50,2W 700mA 2700K CRI90
Light Source 5153lm Luminaire 1863lm
(included)

**Pressed wood or brushed aluminium diffuser.
Injected and lacquered black metal matte aluminium dissipater.**

- Oak - Oak
- Wenge - Wenge
- Oak - White
- Wenge - White
- Brushed brass - Brushed brass
- Black - White
- Mauve (RAL 010 70 10)
- Sand (RAL 050 85 10)
- Stone Grey (RAL 000 65 00)

Range

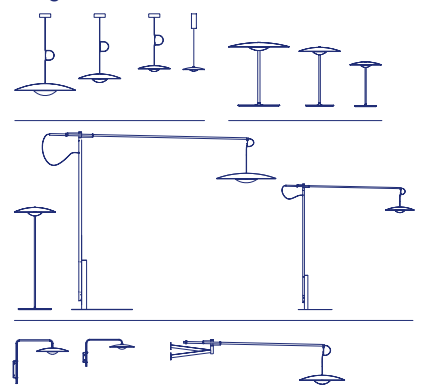

How Ginger illuminates

Ginger 60 C

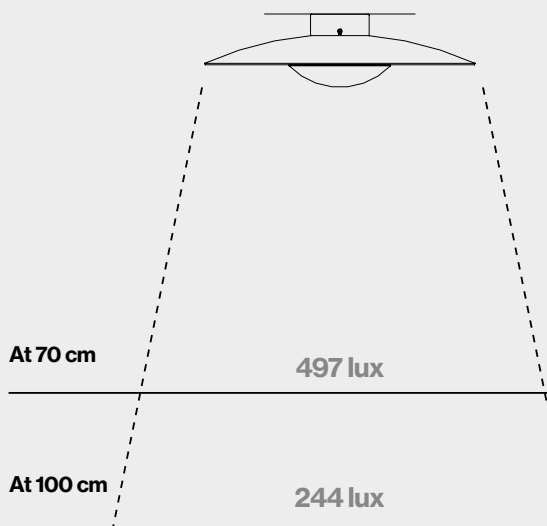

Ginger 42 C

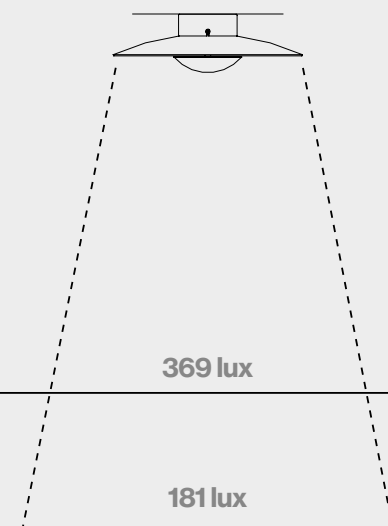

Ginger 32 C

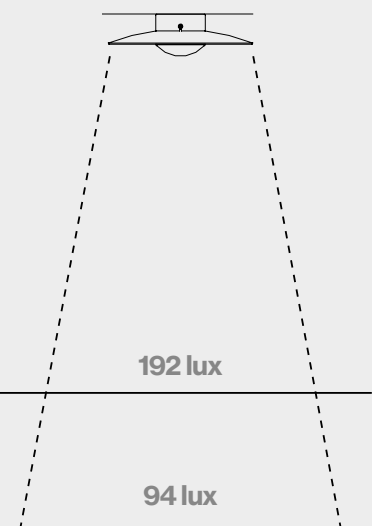

Ginger 20 C

